

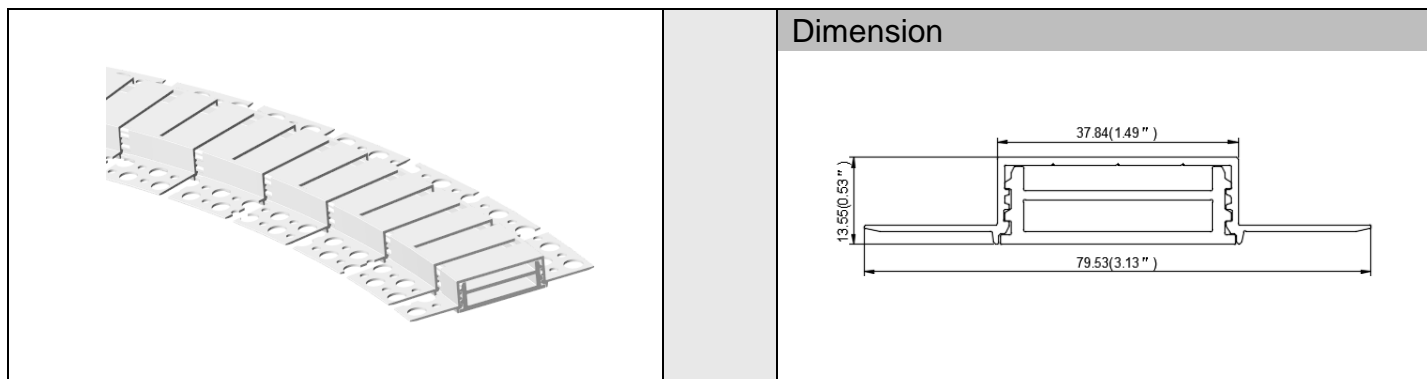

Model : ALP217-R



Specification

Aluminum Profile	6063-T5
Diffuser	silicone diffuser
Length	2000mm
Weight	0.5kg/m
Max LED Strip Width	34mm
Max Power	20W/m
Beam angle	/
Finish	Silver / Black anodized , Powder coated white / black or other colors
Installation	Recessed

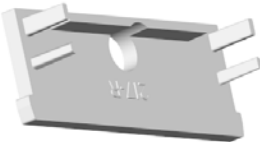
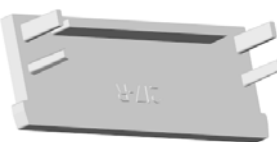
Accessories

			
End cap with hole	End cap without hole	LED Strip	180° Connector (Metal)
			
Pearl cotton			

Steps of Installation

Method 1

1. Install the end caps

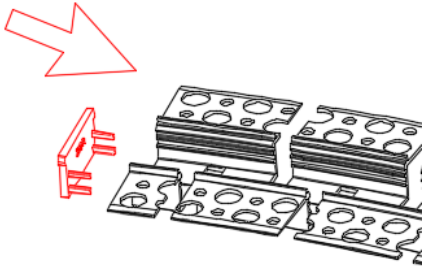

2. Install the profile with screws

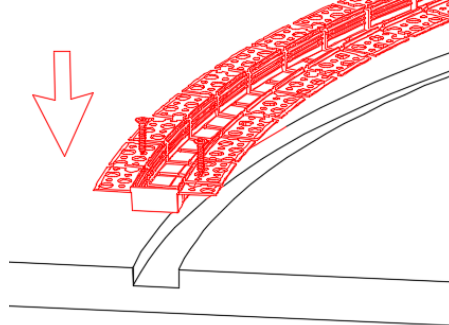

3. insert the Pearl cotton

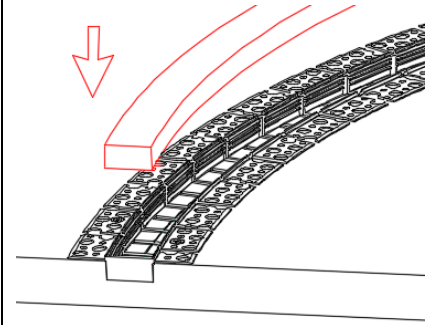

4. Plaster on the fixture & drywall

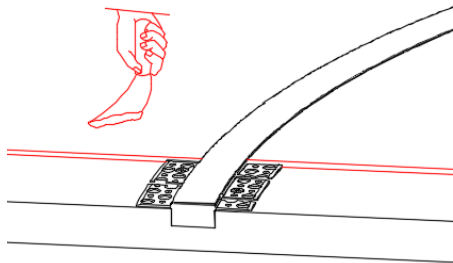

5. Stick the LED strip

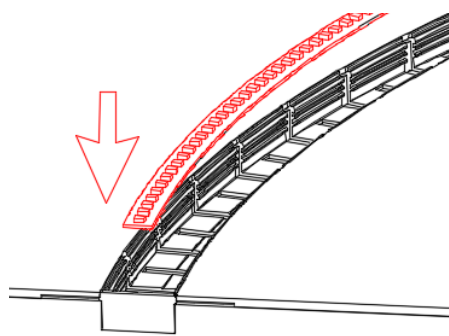

6. Press the cover

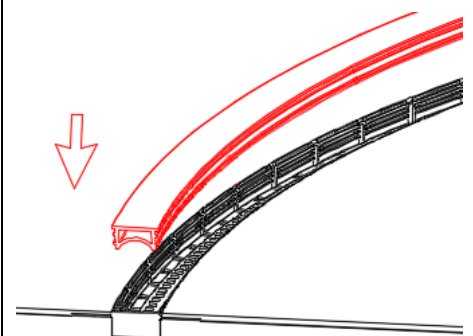

7. Installation completed



Method 2

1. Install the end caps

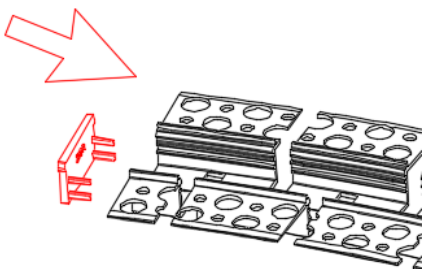

2. Install the profile with screws

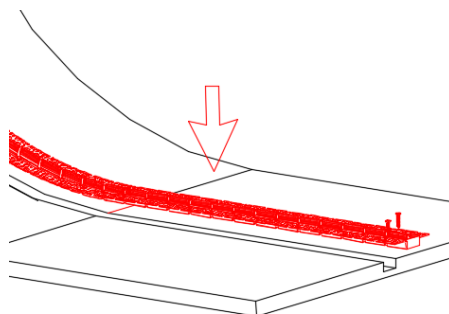

3. insert the Pearl cotton

