

Model : ALP001-R

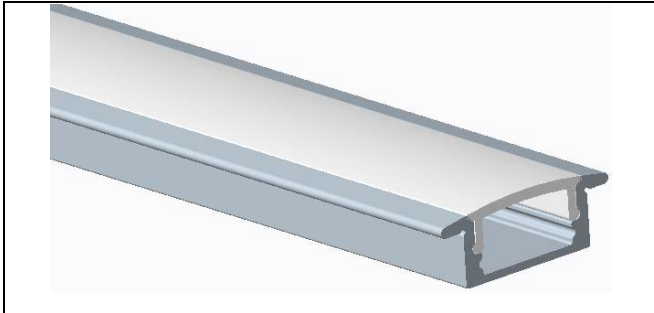

Dimension

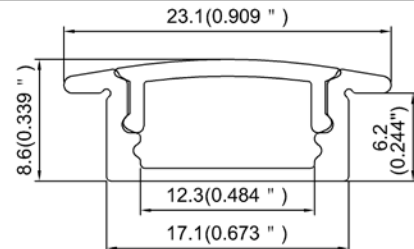

Specification

Aluminum Profile	6063-T5
Diffuser	PC diffused cover / PMMA opal cover / PMMA semi-clear cover / PMMA clear cover
Length	2000mm / 2500mm / 3000mm
Weight	0.162kg/m
Max LED Strip Width	12mm
Max Power	15W/m
Beam angle	100°
Finish	Silver / Black anodized , Powder coated white / black or other colors
Installation	Recessed

Accessories



End cap with hole(ABS)



End cap without hole(ABS)



LED Strip

Steps of Installation

1. Stick the LED strip

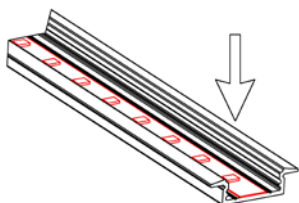

2. Press the diffused cover

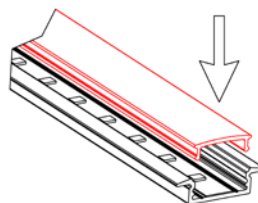

3. Click the end caps

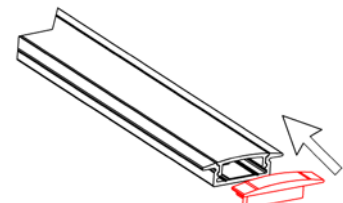

4. Stick the tape on the back of fixture

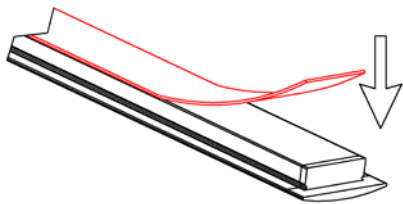

5. Install the fixture on the wall

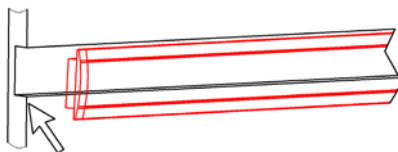

6. Installation completed

