

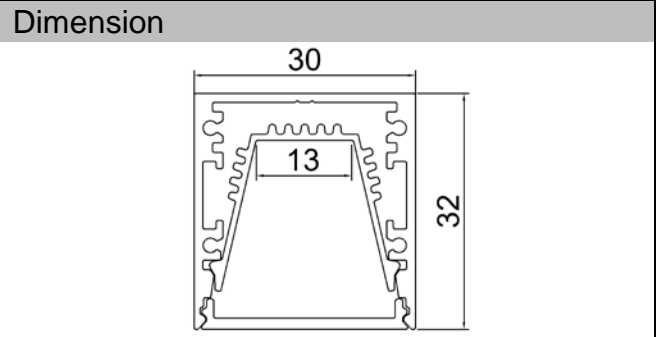

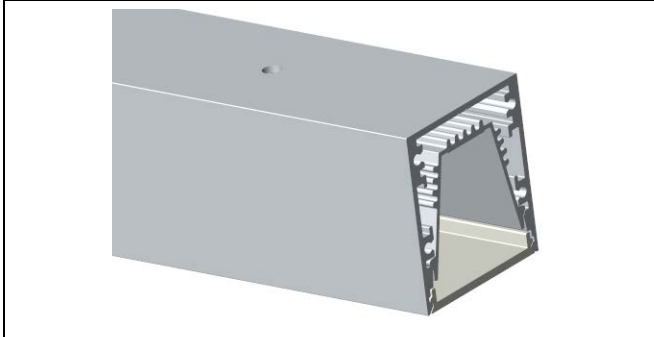



Model : ALP3030

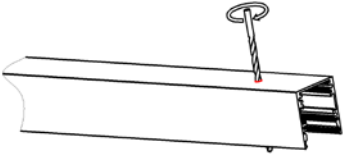
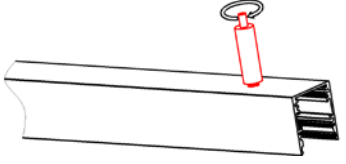
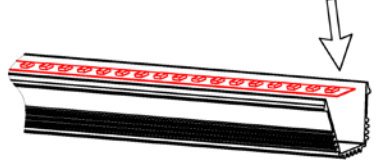
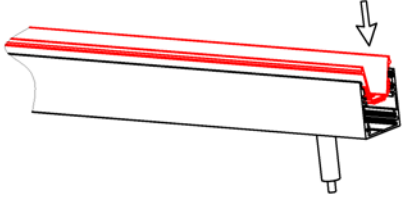
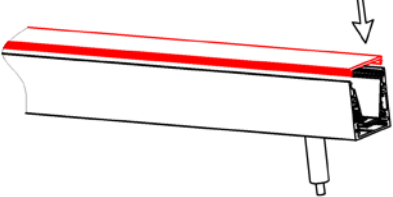
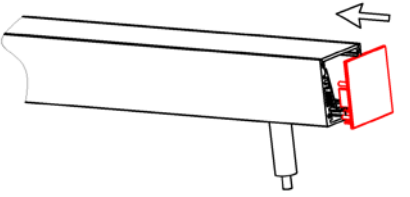
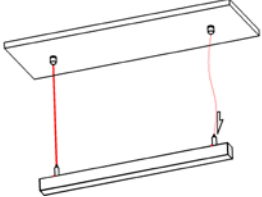
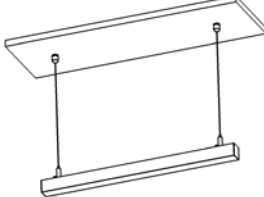
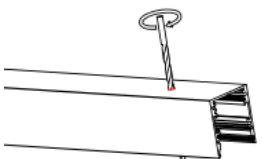

Specification	
Aluminum Profile	6065-T5
Diffuser	PC frosted cover
Length	2000mm / 2500mm / 3000mm
Weight	0.711kg/m
Max LED Strip Width	12mm
Max Power	18W/m
Beam angle	100°
Finish	Silver / Black anodized , Powder coated white / black or other colors
Installation	Surface/Pendant

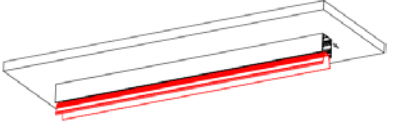
Accessories			
Die cast end cap (metal)	LED Strip	Steel wire	180° Connector(Metal)
90° Vertical Connector(Metal)	90° Connector(Metal)		

Steps of Installation

<p>1. Drill the holes for power cable & steel wire</p> 	<p>2. Fix the steel wire on the profile A</p> 	<p>3. Stick the LED strip</p> 
<p>4. Click the profile B into the profile A</p> 	<p>5. Click the diffused cover</p> 	<p>6. Fix the end caps</p> 
<p>6. Mounting the steel wire on the ceiling</p> 	<p>7. Installation completed</p> 	<p>PENDANT</p>
<p>1. Drill several holes on the profile for the screw and cable</p> 	<p>1. Mounting the profile A on the ceiling</p> 	<p>2. Stick the LED strip in the profile B</p> 
<p>3. Press the profile B into the profile A</p> 	<p>4. Press the diffused cover</p> 	<p>5. Insert the end caps</p> 
<p>6. Installation completed</p> 		<p>SURFACE</p>