

Model : ALP100

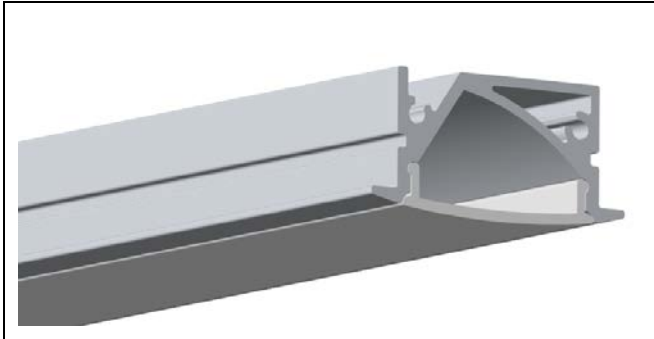

Dimension

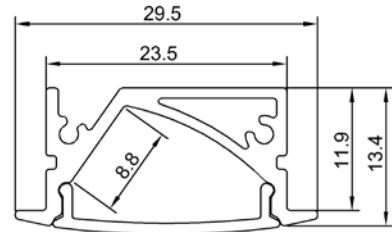

Specification

Aluminum Profile	6063-T5
Diffuser	PC diffused cover
Length	2000mm / 2500mm / 3000mm
Weight	0.308kg/m
Max LED Strip Width	8mm
Max Power	15W/m
Beam angle	100°
Finish	Silver / Black anodized , Powder coated white / black or other colors
Installation	Recessed

Accessories



End Caps (Metal)



Spring Clip (Metal)



LED Strip

Steps of Installation

1. Stick the led strip



2. Click the diffused cover



3. Fix the end caps with screws



A4. Stick the tapes on the back of fixture



A5. Mounting the fixture with tape

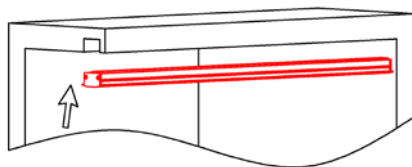

A6. Installation completed

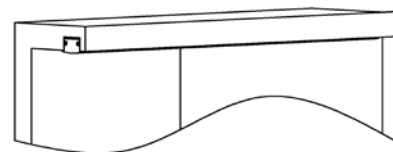

TAPE VERSION

B4. Install the spring clips

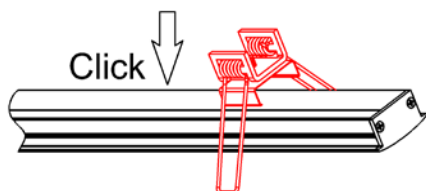

B5. Mounting the fixture with spring clips

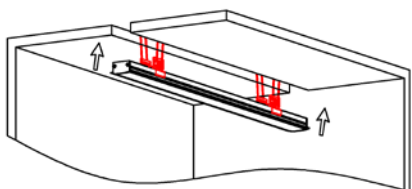

B6. Installation completed .

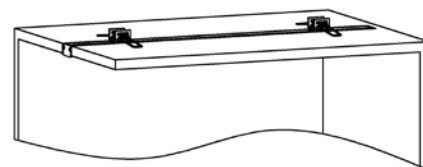

SPRING CLIP VERSION